



M413

TRACK TROMMEL

MDS M413

The M413 3 Split Track is ideal for screening from light material to recycling demolition waste. This machine can also operate in the quarry, cleaning dirty material up to 600mm (24") in size. The unit now comes with three fold out stockpiling conveyors and is ideal for moving around the quarry and from one site to the next.

Suitable for:

- Overburden
- Sticky Dirty Clay
- Rip Rap/Armour Rock
- Recycling Waste
- Limestone
- Primary Screening
- Demolition Waste
- Blasted Rocks

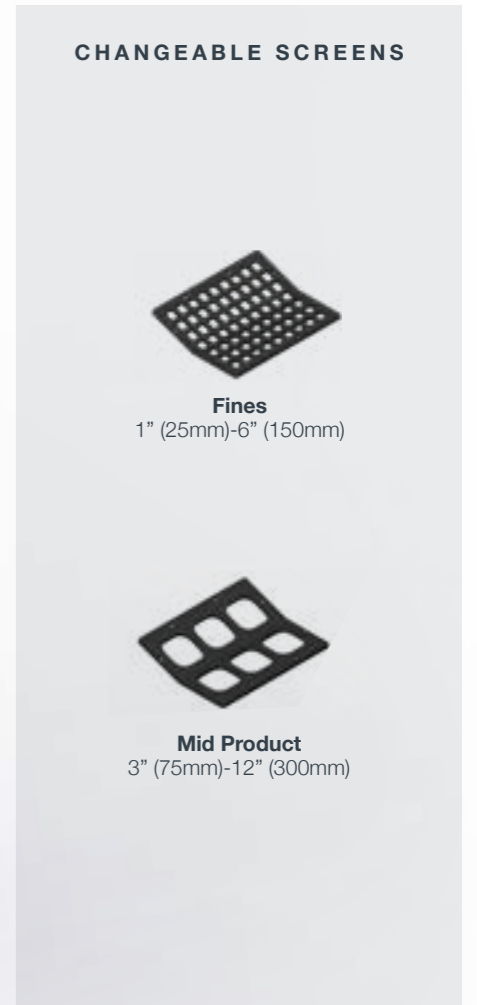
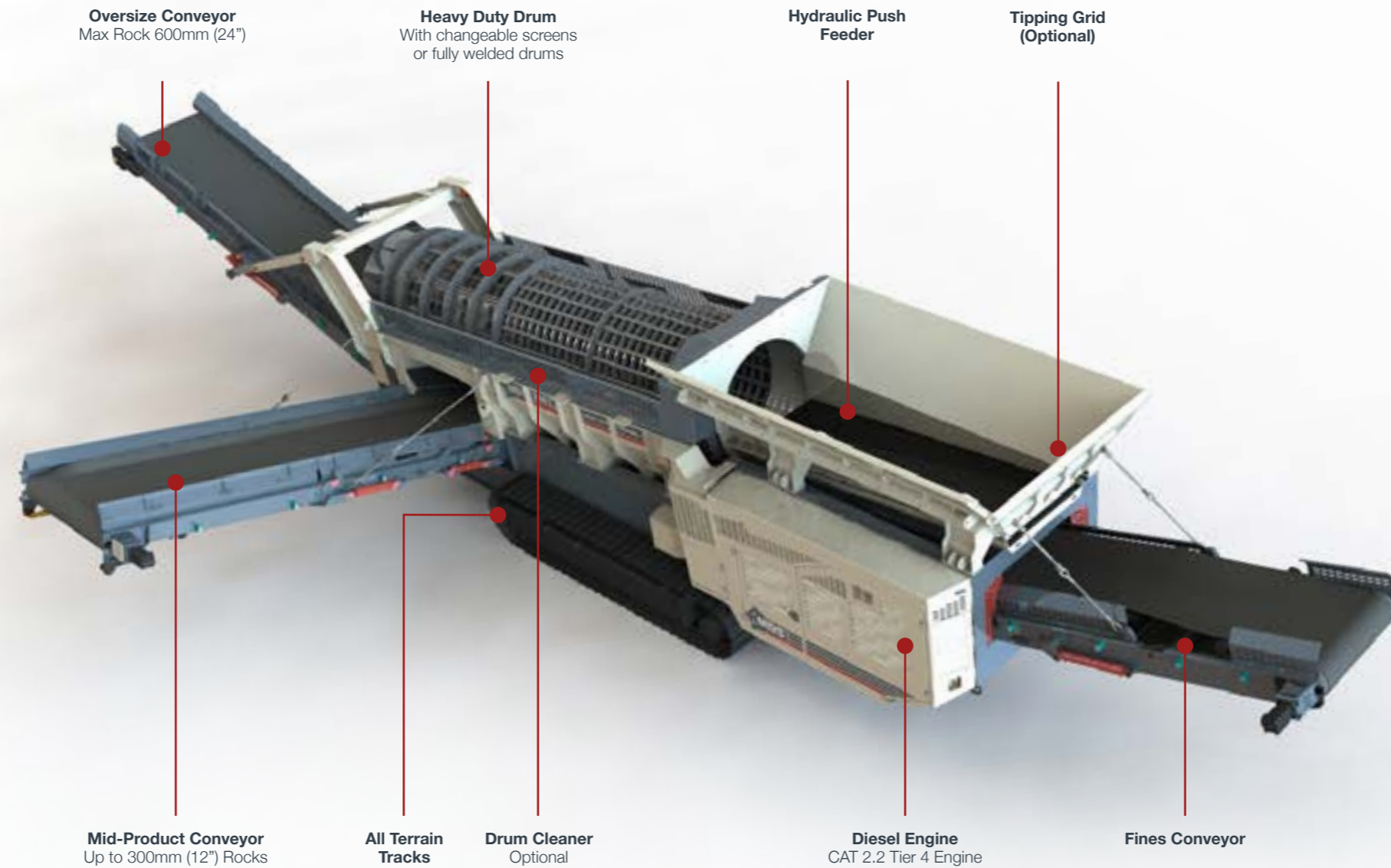

MACHINE SPECIFICATIONS



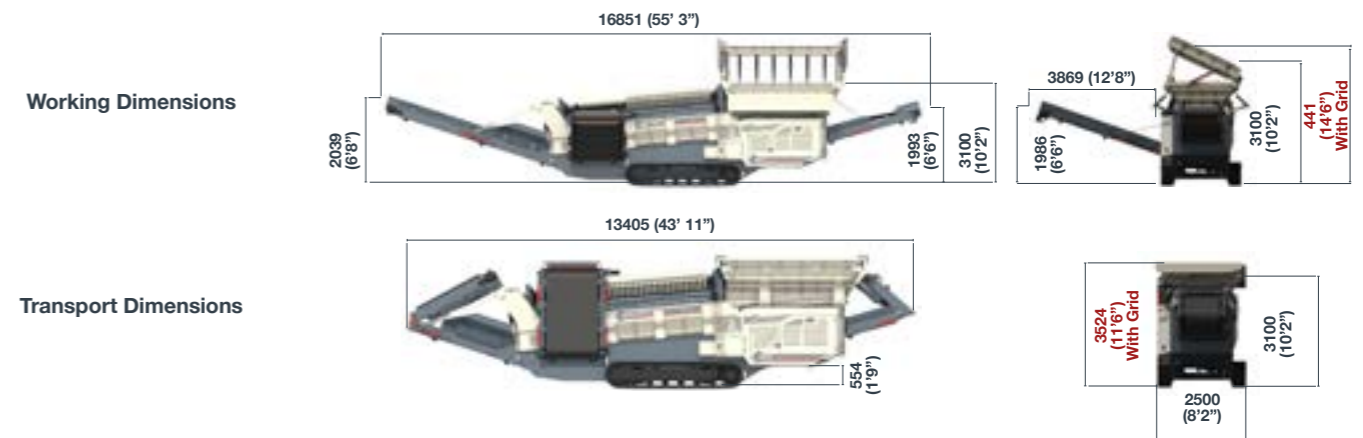

WEIGHT: 29.5 tons (65,036lbs)
TONS PER HOUR: 300 tons
DRUM DIAMETER: 1.25m (4ft 1")
DRUM LENGTH: 4m (13ft 1")
NUMBER OF OUTPUTS: 3 off
MAX ROCK SIZE: 600mm (24")

HOPPER CAPACITY: 4m³ (141 ft³)
ENGINE: 50kW (67HP) Cat 2.2
TRANSPORT LENGTH: 13,405mm (43' 11")
TRANSPORT WIDTH: 2500mm (8'2")
TRANSPORT HEIGHT: 3100mm (10'2"), 3524mm (11' 6") with Grid

TECHNICAL SPECIFICATION DIMENSIONS



MDS TROMMEL RANGE

MODEL		TONS PER HOUR	DRUM DIAMETER /LENGTH	MAX FEED SIZE	NUMBER OF OUTPUTS	SCREEN OPENINGS	HOPPER CAPACITY	FEED MECHANISM	ENGINE AND CONTROLS
 <p>M412 TROMMEL</p>	Mobile track machine for use with primary blast, dirty material or rip rap.	250 to 300 tons	1.25m (4ft 1")/ 4m (13ft 1")	600mm (24")	2 off	25mm to 150mm (1" to 6")	12 tons or 4m ³	Hydraulic Push Feeder	Cat 2.2 Tier 4 Stage 5 Dual Cert
 <p>M413 TROMMEL</p>	A large heavy duty static rock trommel ideal for cleaning dirty rock or screening blasted material.	250 to 300 tons	1.25m (4ft 1")/ 4m (13ft 1")	600mm (24")	3 off	Fines up to 150mm (6") Mid Product up to 300mm (12")	12 tons or 4m ³	Hydraulic Push Feeder	Cat 2.2 Tier 4 Stage 5 Dual Cert
 <p>M515 TROMMEL</p>	Mobile track machine for use with primary blast, dirty material or rip rap.	Up to 500 tons	1.5m (4ft 11")/ 4m (16ft 5")	800mm (32")	3 off	Fines up to 200mm (8") Mid Product up to 460mm (18")	20 tons or 12.6m ³	Hydraulic Push Feeder	Cat 4.4/ Electronic Control System
 <p>M518R TROMMEL</p>	Compact track trommel designed for use in various applications.	Application Specific	1.8m (5ft 11")/ 5m (16ft 5")	-	2 off	5mm to 50mm (0.2" to 2")	5m ³	Hydraulic Push Feeder	Cat 2.2/ Electronic Control System
 <p>M720R TROMMEL</p>	Recycling trommel ideal for screening heavy materials.	800 tons	2m (6ft 6")/ 7m (22ft 11")	800mm (32")	2-4 off	Up to 800mm (32")	15 tons approx	Apron Feeder	Electric/ Control System



Drummond, Magheraclone
A81 TE82, Carrickmacross
Co. Monaghan, Ireland

+353 42 966 7899
mds.info@terex.com
terex.com/mds

